

Article number: 203502702650ST

Description: E+G Levelling sets GN 350.2-70-26-50-ST

Measures

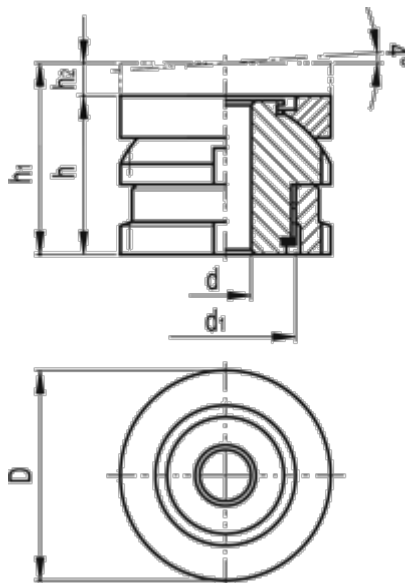

C-spanner DIN 1810 = A68-75

d = 26

D = 70

d1 = M50x1.5

For screw = M24

h = 50

h1 = 60

h2 = 10

Max static load (kN) = 225

Static preload (kN) = 97.3

Weight (g) = 940